

# JLR-21 GPS compass

3D  
Dynamic Sensor™

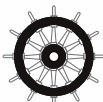

*- the JLR-21 sets a new standard of GPS compass, with its renowned high performance and new features*

**5.7-inch high visibility display**

**Roll, pitch, rate of turn and heave integrated**

**High speed tracking response (ROT 45°/sec)**

**Wide range of new display modes available**

**Dynamic heading accuracy 0.5° rms**

# JLR-21

## - features

### Features

The JLR-21 GPS compass continues the success of its predecessor, reaching a new level of performance and stability with many new features and enhancements. This system is also known as a 3D Dynamic Sensor™, which besides giving heading information, is designed to provide highly accurate information of the ships movement in all axis.

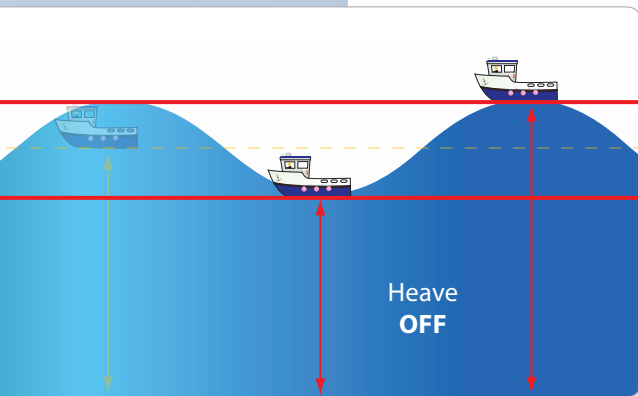

### Heave compensation

The JLR-21 has heave functionality built-in as standard. In rough ocean conditions (with high waves), the GPS compass can correct up and down (attitude), movement. This is especially useful for fish finders and sonars on fishing vessels where high waves are compensated for

with up to 20 cm accuracy, providing better potential for a profitable catch.

#### Sentence

ATT  
HVE

#### Data

Heading, rolling, pitching  
Heaving

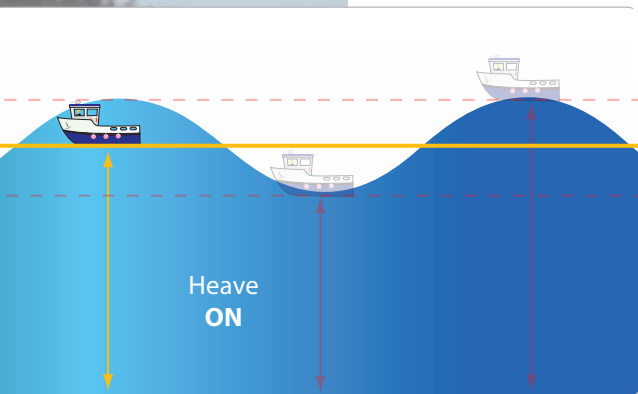

### High speed update

The JLR-21 supports Speed Over Ground (SOG) and Course Over Ground (COG). The position, SOG and COG are updated every 200 milliseconds (which is 5 times faster than previous model JLR-20), delivering high accuracy.

#### Data

Heading, ROT, rolling, pitching, heaving  
Position, SOG, COG

#### Cycle

Every 20 milliseconds  
Every 200 milliseconds

### High speed tracking

The GPS compass has its origins as a direction sensing system, but the JLR-21 goes far beyond that. The JLR-21 provides heading accuracy of 0.5°. Our other model (JLR-31) has an impressive 0.25° heading accuracy. Heave accuracy is 20 cm or better and roll and pitch for both models is 0.5°. The tracking Rate of Turn (ROT) is 45° per second.

On the right a comparison between previous GPS compass model (JLR-20) and the new model (JLR-21).

#### Features

Roll  
Pitch  
Rate of Turn  
Position  
Heave  
High speed update  
Trip log  
Anchor watch  
CCRP  
RMS  
Trend graph

#### JLR-20

✓  
✓  
✓  
✓

#### JLR-21

✓  
✓  
✓  
✓  
✓  
✓  
✓  
✓  
✓  
✓

# JLR-21

## - advanced technology

### Display modes

The JLR-21 incorporates many display modes readily available on a highly visible 5.7 inch LCD display. The display is fully dimmable and the keys are also backlit, making it easy to operate in low-light settings on the bridge.



### Simple operation

The compact design of the JLR-21 incorporates an intuitive interface, providing enhanced ergonomics and user friendliness. The logic of the controls and excellent on-screen menus will greatly shorten most users' learning period.

### Antenna design

The processor is built into the antenna. Eliminating alignment between antenna and processor found in separate systems, therefore contributing to an easy setup with less error and significantly reduced installation time. This concept also reduces the installation costs as only a single cable is used between antenna and display unit.

The outer shell of JRC's new antenna system has a smooth surface. This slippery exterior makes it almost impossible for birds to perch on the domes or for the antennas to be completely covered in snow.

Should something interfere with the coverage, JRC's proven antenna design incorporates a layer of air that reduces possible blind spots, allowing for a more precise heading than conventional systems.

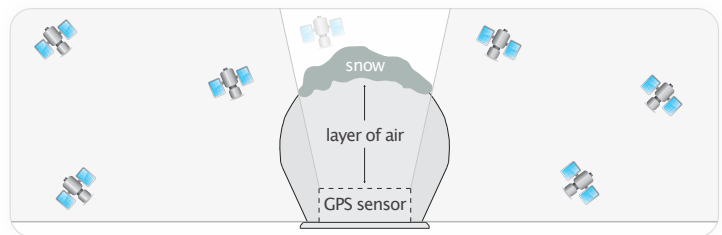

· JRC proven high performance antenna design

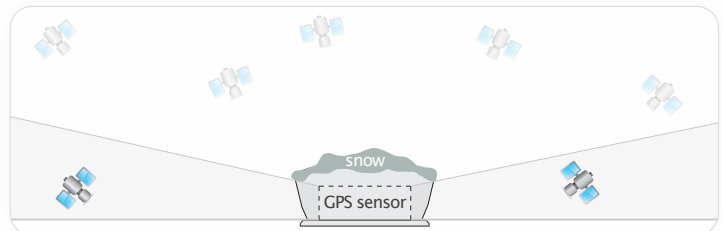

· Conventional antenna system



NNN-21

### Installation and maintenance

The JLR-21 display is compactly designed and can be mounted virtually anywhere. The three-antenna system is exclusively designed by JRC, making it far more reliable than conventional antenna systems. The system has a short start-up time (less than 2 minutes). Maintenance is not required, making it less expensive to maintain than a standard gyro system.



### Remote Maintenance System (RMS)

JRC has the ability to cost-effectively monitor performance and functionality of the JLR-21 while at sea, significantly reducing downtime and maintenance costs. [More at jrceurope.com/support](http://More at jrceurope.com/support) ▶

# JLR-21

## - unique functions



### Measuring tool

The GPS compass allows calculation of distance and bearing between any two points, supporting Rhumb Lines (RL) for the short legs and Great Circle (GC) for long distance legs. Also, a trip log function comes standard for distance and heading.

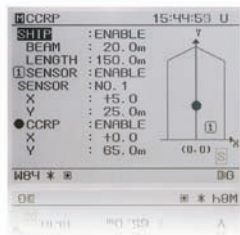

### CCRP and Anchor watch

The JLR-21 has CCRP<sup>1</sup> function incorporated, allowing the transfer of CCRP sentences to other onboard equipment and anchor watch alerts the watch officer of possible anchor dragging situations.

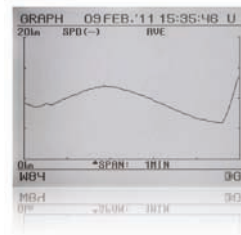

### Trend graph

The new trend graph display mode shows a history of roll, pitch and heave and SOG as an easy-to-read graphical view. Selections can be made to show maximum or average results.

### Interfaces

The new GPS compass integrates 5 independent working NMEA output ports, which allows for connection to a wide range of onboard navigation equipment, such as radar, plotter, autopilot, sonar or other navigation devices.

### JLR-21 and IMO recommendations

Traditionally, the means used to measure the heading of a ship has been a mechanical gyrocompass and/or a traditional magnetic compass. With the adoption of the new installation requirements in SOLAS-V, all passenger ships and all ships from 300 to 500 GT travelling international routes can now install a new technology directional sensor, the Transmitting Heading Device (THD). JRC's new JLR-21 has been approved as both a THD and a GNSS (GPS).

The approval allows for installation as a primary heading device on vessels up to 500 GT and for vessels over 500 GT, two or more could be installed as GNSS (GPS) or backup heading device depending upon flag/class agreement.

	GPS compass	Gyro compass	Magnetic compass
<b>Periodic maintenance</b>	No	Yes	Yes for correction deviation
<b>Settling time</b>	approx 2 min.	about 4 hours	no
<b>Tracking response</b>	High speed	High speed	Low speed
<b>Accuracy</b>	Good	Good	Bad
<b>Magnetic influence</b>	No	No	Yes
<b>Correction</b>	No	Yes for latitude	Yes for variation

### Standard in the box

- Display
- Antenna
- Cables
- Installation parts
- Spare parts
- Manual

#### Cables

- Power cable display 2 m
- Serial data cable 3 m
- Display to antenna<sup>2</sup> 10 m

### Options

- Serial data cable CFQ-5374 (3 m)
- Sensor extension cable CFQ-7250 (20 m)
- Flush mount kit MPBC43664
- AC power rectifier NBG-320
- DGPS receiver JLR-4341

See all options [jrceurope.com](http://jrceurope.com)

1. Consistent Common Reference Point

2. The cable length may vary depending on sales region.



Japan Radio Co., Ltd.

# JLR-21

## - size and weight

### Display

NWZ-4701 Weight 2,3 kg

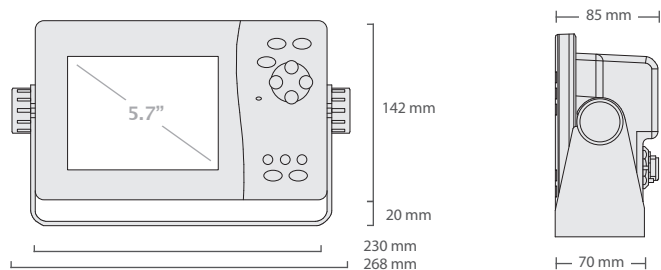

Cutout dimensions for flush mounting	
Height	116 mm
Width	220 mm
Depth	64 mm

### Antenna

NNN-21 Weight 5,9 kg

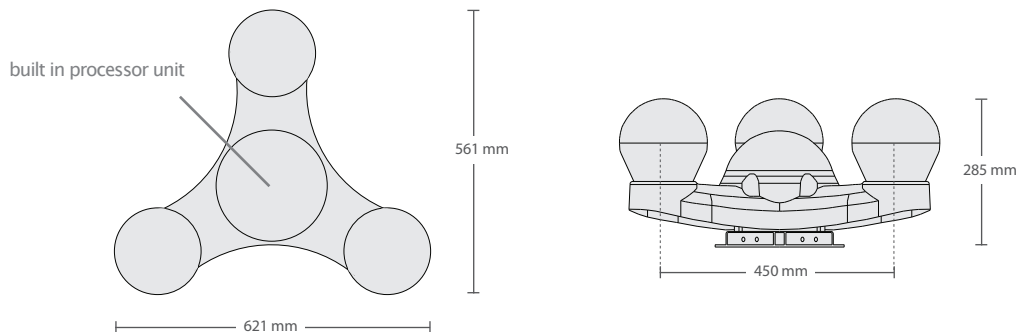

### System diagram

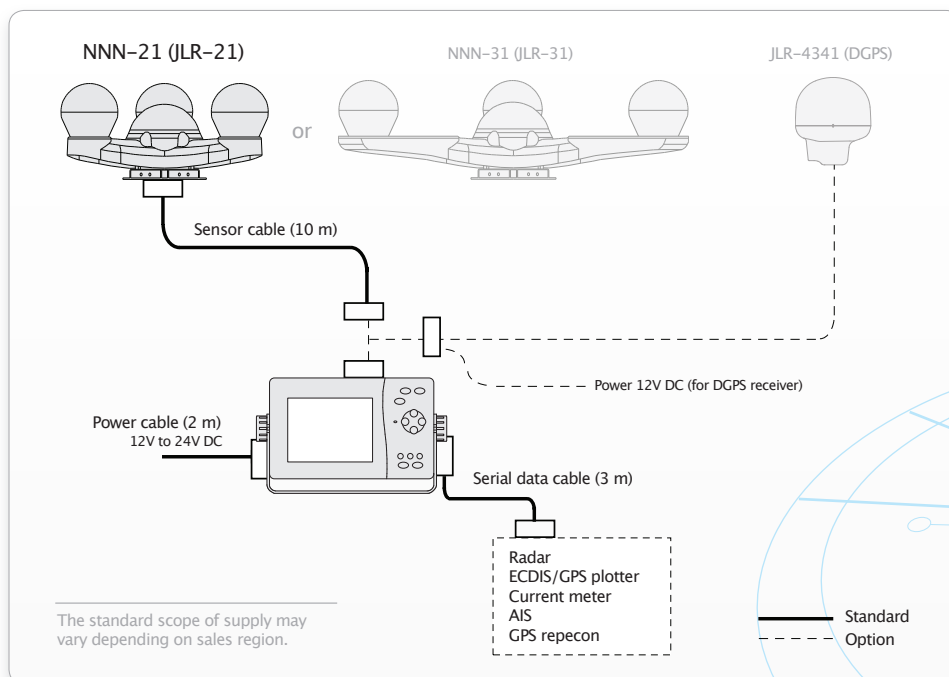

The maximum cable length between antenna and display is 50 m. Note that extensions should be of a shielded multicore cable to prevent noise or attenuation.

# JLR-21

## - specifications

	JLR-21
IMO approved	✓
Receiver type	Multi channel all-in-view (12ch + 1ch SBAS)
Frequency	1575.42MHz ± 1MHz (C/A code)
Direction accuracy	0.5° rms
Display resolution	0.1°
Resolution output	0.1° or 0.01° (selectable)
Tracking Rate of Turn	45°/sec
Tracking acceleration	1G
Roll/pitch output	-60° to 60°
Startup time	less than 2 minutes (warm start fix)
DGPS input	RTCM SC-104 version 2.0 (type 1, 2, 9, 16)
SBAS receiver	Built-in (WAAS/EGNOS/MSAS)
RAIM function	Built-in
Position accuracy	12m 2drms (C/A code, HDOP=<4, SA OFF) 6m 2drms when SBAS corrected 4m 2drms when DGPS corrected (when connected to beacon receiver)
Display	5.7-inch LCD, 320 by 240 pixels
Operating keys & backlight	12 keys, LED (display and backlight keys)
Dimmer levels	4 levels (bright, medium, dark, off)
Display modes	Compass rose, bow heading, navigation, rate of turn (ROT), water/ground speed, trend graph, calculation, GPS status
Output ports	5 independent working NMEA0183 ports
NMEA0183 version	1.5, 2.1, 2.3
Transmission speed	4800, 9600, 19200, 38400, 57600 bps
Output interval	20ms, 25ms, 50ms, 100ms, 200ms, 500ms, 1s, 2s, 3s, 4s, 5s, 6s, 7s, 8s, 9s
Sentence <sup>1</sup>	IEC61162/NSK (shared) 5 ports (AD10 output available: 2 of 5 ports) IEC61162 output: HDT, THS, ROT, ZDA, GGA, VTG, RMC, GBS, DTM, GSA, GSV, GNS, MSS, GST, GLL, ALR, ATT, HVE
Current data input	1 port (CUR, VBW)
Alarm contact signal	2 ports (alarm output), 1 port (ACK input)
LOG pulse	1 port (off, 200p/nm, 400p/nm)
Power	12V to 24 V DC (-10% to +30%)
Power consumption	12 W (including sensor), 6 W (excluding sensor)
Ambient conditions	-15° to 55°C (operating), -25° to 70°C (storage)
Waterproof	IPX4 (display), IPX6 (sensor)

1. Selectable sentences depend on version. ATT and HVE sentence can be set from output cycles of 25ms, 100ms, 200ms, 1s, 2s only. Some combinations of output sentence, bit rates, and output intervals may not be possible.

**JRC in Europe/Africa**  
Cessnalaan 40-42  
1119 NL Schiphol-Rijk  
The Netherlands

T +31 20 658 0750  
F +31 20 658 0755  
W jrceurope.com

**JRC in Asia/Oceania**  
Fujisawa bldg. 30-16  
Ogikubo 4-chome Suginami-ku  
Tokyo 167-8540, Japan

T +81 3 6832 1721  
F +81 3 6832 1845  
W jrc.co.jp

**JRC in the Americas**  
1011 SW Klickitat Way, B-201  
Seattle, WA 98134  
USA

T +1 206 654 5644  
F +1 206 654 7030  
W jrcamerica.com

# JLR-31 GPS compass

3D  
Dynamic Sensor™

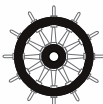

*- the JLR-31 sets a new standard of GPS compass, with its renowned high performance and new features*

**5.7-inch high visibility display**

**Roll, pitch, rate of turn and heave integrated**

**High speed tracking response (ROT 45°/sec)**

**Wide range of new display modes available**

**Dynamic heading accuracy 0.25° rms**

# JLR-31

## - features

### Features

The JLR-31 GPS compass continues the success of its predecessor, reaching a new level of performance and stability with many new features and enhancements. This system is also known as a 3D Dynamic Sensor™, which besides giving heading information, is designed to provide highly accurate information of the ships movement in all axis.

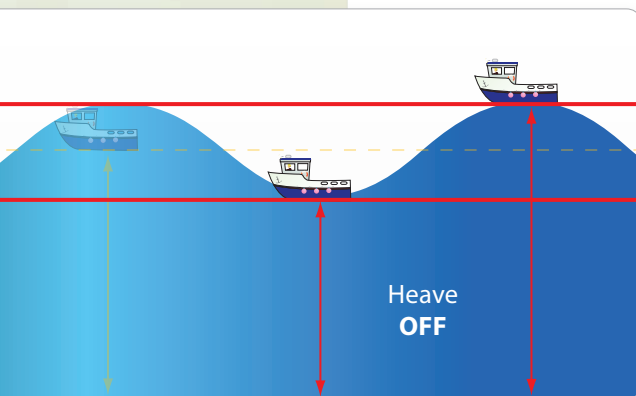

### Heave compensation

The JLR-31 has heave functionality built-in as standard. In rough ocean conditions (with high waves), the GPS compass can correct up and down (attitude), movement. This is especially useful for fish finders and sonars on fishing vessels where high waves are compensated for

with up to 20 cm accuracy, providing better potential for a profitable catch.

#### Sentence

ATT  
HVE

#### Data

Heading, rolling, pitching  
Heaving

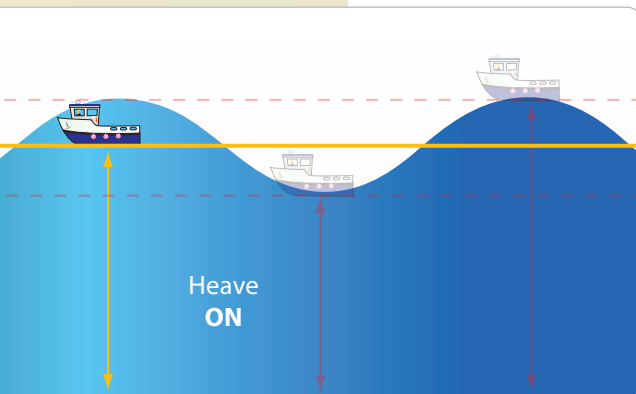

### High speed update

The JLR-31 supports Speed Over Ground (SOG) and Course Over Ground (COG). The position, SOG and COG are updated every 200 milliseconds (which is 5 times faster than previous model JLR-30), delivering high accuracy.

#### Data

Heading, ROT, rolling, pitching, heaving  
Position, SOG, COG

#### Cycle

Every 20 milliseconds  
Every 200 milliseconds

### High speed tracking

The GPS compass has its origins as a direction sensing system, but the JLR-31 goes far beyond that. The JLR-31 provides an impressive heading accuracy of 0.25°. Our other model (JLR-21) has an 0.5° heading accuracy. Heave accuracy is 20 cm or better and roll and pitch for both models is 0.5°. The tracking Rate of Turn (ROT) is 45° per second.

On the right a comparison between previous GPS compass model (JLR-30) and the new model (JLR-31).

#### Features

Roll  
Pitch  
Rate of Turn  
Position  
Heave  
High speed update  
Trip log  
Anchor watch  
CCRP  
RMS  
Trend graph

#### JLR-30

✓  
✓  
✓  
✓

#### JLR-31

✓  
✓  
✓  
✓  
✓  
✓  
✓  
✓  
✓  
✓  
✓



# JLR-31

## - advanced technology

### Display modes

The JLR-31 incorporates many display modes readily available on a highly visible 5.7 inch LCD display. The display is fully dimmable and the keys are also backlit, making it easy to operate in low-light settings on the bridge.



### Simple operation

The compact design of the JLR-31 incorporates an intuitive interface, providing enhanced ergonomics and user friendliness. The logic of the controls and excellent on-screen menus will greatly shorten most users' learning period.

### Antenna design

The processor is built into the antenna. Eliminating alignment between antenna and processor found in separate systems, therefore contributing to an easy setup with less error and significantly reduced installation time. This concept also reduces the installation costs as only a single cable is used between antenna and display unit.

The outer shell of JRC's new antenna system has a smooth surface. This slippery exterior makes it almost impossible for birds to perch on the domes or for the antennas to be completely covered in snow.

Should something interfere with the coverage, JRC's proven antenna design incorporates a layer of air that reduces possible blind spots, allowing for a more precise heading than conventional systems.

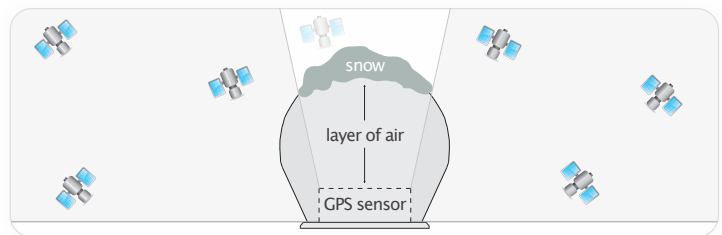

· JRC proven high performance antenna design

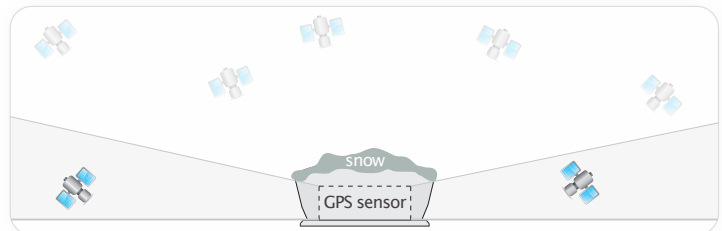

· Conventional antenna system



NNN-31

### Installation and maintenance

The JLR-31 display is compactly designed and can be mounted virtually anywhere. The three-antenna system is exclusively designed by JRC, making it far more reliable than conventional antenna systems. The system has a short start-up time (less than 2 minutes). Maintenance is not required, making it less expensive to maintain than a standard gyro system.



### Remote Maintenance System (RMS)

JRC has the ability to cost-effectively monitor performance and functionality of the JLR-31 while at sea, significantly reducing downtime and maintenance costs. [More at jrceurope.com/support](http://More at jrceurope.com/support) ▶

# JLR-31

## - unique functions



### Measuring tool

The GPS compass allows calculation of distance and bearing between any two points, supporting Rhumb Lines (RL) for the short legs and Great Circle (GC) for long distance legs. Also, a trip log function comes standard for distance and heading.

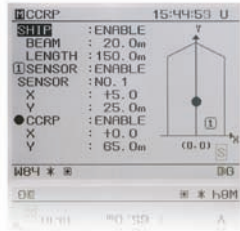

### CCRP and Anchor watch

The JLR-31 has CCRP<sup>1</sup> function incorporated, allowing the transfer of CCRP sentences to other onboard equipment and anchor watch alerts the watch officer of possible anchor dragging situations.

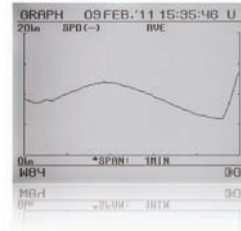

### Trend graph

The new trend graph display mode shows a history of roll, pitch and heave and SOG as an easy-to-read graphical view. Selections can be made to show maximum or average results.

### Interfaces

The new GPS compass integrates 5 independent working NMEA output ports, which allows for connection to a wide range of onboard navigation equipment, such as radar, plotter, autopilot, sonar or other navigation devices.

### JLR-31 and IMO recommendations

Traditionally, the means used to measure the heading of a ship has been a mechanical gyrocompass and/or a traditional magnetic compass. With the adoption of the new installation requirements in SOLAS-V, all passenger ships and all ships from 300 to 500 GT travelling international routes can now install a new technology directional sensor, the Transmitting Heading Device (THD). JRC's new JLR-31 has been approved as both a THD and a GNSS (GPS).

The approval allows for installation as a primary heading device on vessels up to 500 GT and for vessels over 500 GT, two or more could be installed as GNSS (GPS) or backup heading device depending upon flag/class agreement.

	GPS compass	Gyro compass	Magnetic compass
<b>Periodic maintenance</b>	No	Yes	Yes for correction deviation
<b>Settling time</b>	approx 2 min.	about 4 hours	no
<b>Tracking response</b>	High speed	High speed	Low speed
<b>Accuracy</b>	Good	Good	Bad
<b>Magnetic influence</b>	No	No	Yes
<b>Correction</b>	No	Yes for latitude	Yes for variation

### Standard in the box

- Display
- Antenna
- Cables
- Installation parts
- Spare parts
- Manual

#### Cables

- Power cable display 2 m
- Serial data cable 3 m
- Display to antenna<sup>2</sup> 10 m

### Options

- Serial data cable CFQ-5374 (3 m)
- Sensor extension cable CFQ-7250 (20 m)
- Flush mount kit MPBC43664
- AC power rectifier NBG-320
- DGPS receiver JLR-4341

See all options [jrceurope.com](http://jrceurope.com)

1. Consistent Common Reference Point

2. The cable length may vary depending on sales region.



Japan Radio Co., Ltd.

# JLR-31

## - size and weight

### Display

NWZ-4701 Weight 2,3 kg

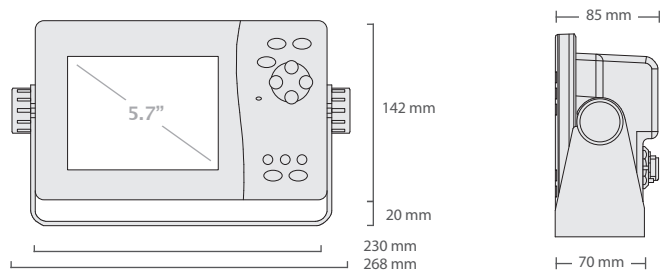

Cutout dimensions for flush mounting	
Height	116 mm
Width	220 mm
Depth	64 mm

### Antenna

NNN-31 Weight 10 kg

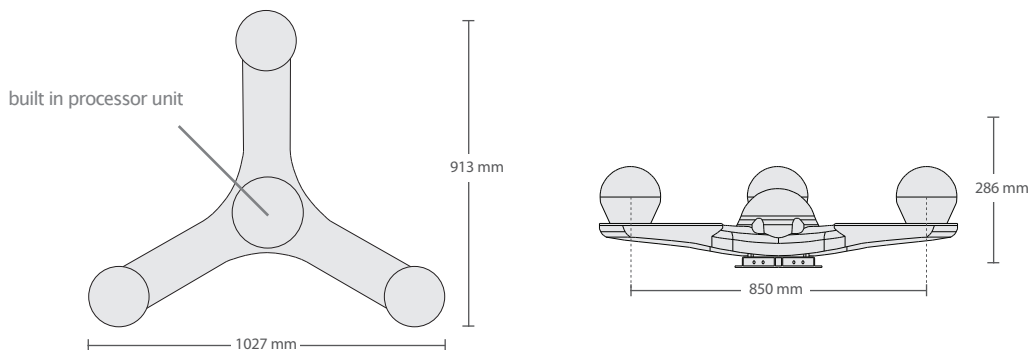

### System diagram

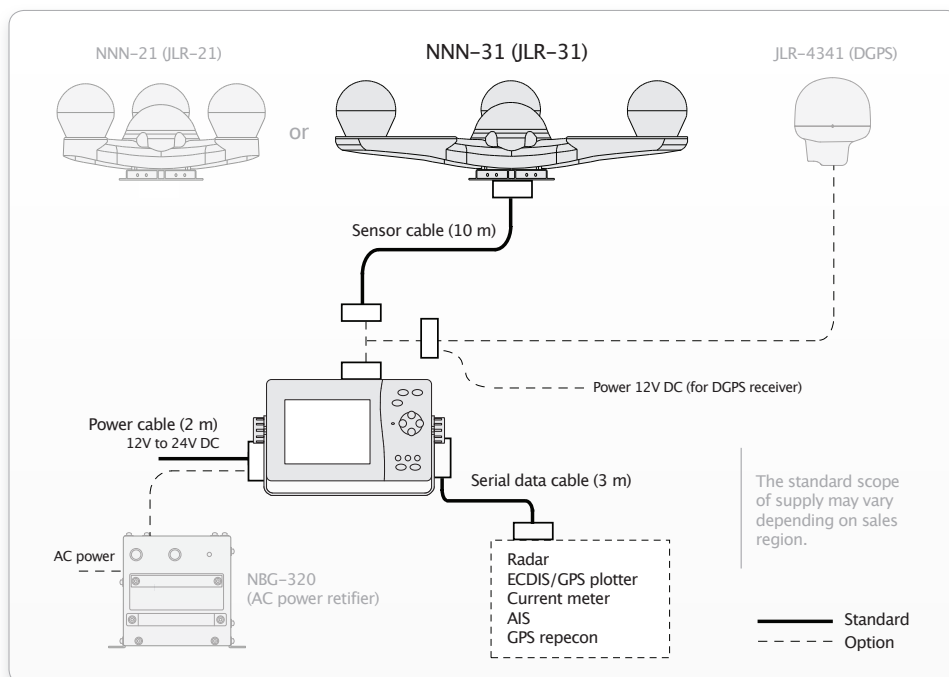

The maximum cable length between antenna and display is 50 m. Note that extensions should be of a shielded multicore cable to prevent noise or attenuation.

# JLR-31

## - specifications

	JLR-31
IMO approved	✓
Receiver type	Multi channel all-in-view (12ch + 1ch SBAS)
Frequency	1575.42MHz ± 1MHz (C/A code)
Direction accuracy	0.25° rms
Display resolution	0.1°
Resolution output	0.1° or 0.01° (selectable)
Tracking Rate of Turn	45°/sec
Tracking acceleration	1G
Roll/pitch output	-60° to 60°
Startup time	less than 2 minutes (warm start fix)
DGPS input	RTCM SC-104 version 2.0 (type 1, 2, 9, 16)
SBAS receiver	Built-in (WAAS/EGNOS/MSAS)
RAIM function	Built-in
Position accuracy	12m 2drms (C/A code, HDOP=<4, SA OFF) 6m 2drms when SBAS corrected 4m 2drms when DGPS corrected (when connected to beacon receiver)
Display	5.7-inch LCD, 320 by 240 pixels
Operating keys & backlight	12 keys, LED (display and backlight keys)
Dimmer levels	4 levels (bright, medium, dark, off)
Display modes	Compass rose, bow heading, navigation, rate of turn (ROT), water/ground speed, trend graph, calculation, GPS status
Output ports	5 independent working NMEA0183 ports
NMEA0183 version	1.5, 2.1, 2.3
Transmission speed	4800, 9600, 19200, 38400, 57600 bps
Output interval	20ms, 25ms, 50ms, 100ms, 200ms, 500ms, 1s, 2s, 3s, 4s, 5s, 6s, 7s, 8s, 9s
Sentence <sup>1</sup>	IEC61162/NSK (shared) 5 ports (AD10 output available: 2 of 5 ports) IEC61162 output: HDT, THS, ROT, ZDA, GGA, VTG, RMC, GBS, DTM, GSA, GSV, GNS, MSS, GST, GLL, ALR, ATT, HVE
Current data input	1 port (CUR, VBW)
Alarm contact signal	2 ports (alarm output), 1 port (ACK input)
LOG pulse	1 port (off, 200p/nm, 400p/nm)
Power	12V to 24 V DC (-10% to +30%)
Power consumption	12 W (including sensor), 6 W (excluding sensor)
Ambient conditions	-15° to 55°C (operating), -25° to 70°C (storage)
Waterproof	IPX4 (display), IPX6 (sensor)

1. Selectable sentences depend on version. ATT and HVE sentence can be set from output cycles of 25ms, 100ms, 200ms, 1s, 2s only. Some combinations of output sentence, bit rates, and output intervals may not be possible.

**JRC in Europe/Africa**  
Cessnalaan 40-42  
1119 NL Schiphol-Rijk  
The Netherlands

T +31 20 658 0750  
F +31 20 658 0755  
W jrceurope.com

**JRC in Asia/Oceania**  
Fujisawa bldg. 30-16  
Ogikubo 4-chome Suginami-ku  
Tokyo 167-8540, Japan

T +81 3 6832 1721  
F +81 3 6832 1845  
W jrc.co.jp

**JRC in the Americas**  
1011 SW Klickitat Way, B-201  
Seattle, WA 98134  
USA

T +1 206 654 5644  
F +1 206 654 7030  
W jrcamerica.com